

MU6D Series

6W, Wide 4:1 Input Range, 1.5KV Isolation, DIP24 Package DC/DC Converters

Features

- ▶ Rated power: 6W Max
- ▶ Input voltage range 4:1
- ▶ Regulated single or dual out
- ▶ High efficiency up to 88%
- ▶ Standby power 0.12W only
- ▶ Isolation voltage 1.5KVdc
- ▶ Operating temperature range: -40 ~ +85°C ambient
- ▶ No external components required for operating
- ▶ RoHS compliant
- ▶ Six side metal shielding
- ▶ Compact DIP24 package
- ▶ Under voltage, over voltage, over current, and short circuit protection
- ▶ Designed to meet UL62368-1, IEC/EN62368-1
- ▶ 5 year warranty



Overview

The MU6D series are 1.5KV isolated 6Watt DC/DC converters with standard DIP24 footprint. Designed with high efficiency, they operate in a wide temperature range from -40°C to +85°C. Other features include wide 4:1 input voltage range, under voltage, over voltage, over current, and short circuit protections. These converters are ideally suitable for measurement equipment, telecom, wireless network, industrial control system, where isolated, tightly regulated voltages are desired.

Model Numbers

Model Number	Input Voltage [VDC]			V _{OUT} [VDC]	Output Current [mA]		Efficiency [%] Typ.	Capacitive Load [uF] Max.
	Nom.	*Range	*Max.		Max.	Min.		
MU6D-2403	24	9~36	40	3.3	1500	0	77	1800
MU6D-2405	24	9~36	40	5	1200	0	82	1000
MU6D-2409	24	9~36	40	9	667	0	83	680
MU6D-2412	24	9~36	40	12	500	0	85	470
MU6D-2415	24	9~36	40	15	400	0	86	220
MU6D-2424	24	9~36	40	24	250	0	86	100
MU6D-2405D	24	9~36	40	±5	±600	0	82	680
MU6D-2409D	24	9~36	40	±9	±333	0	84	220
MU6D-2412D	24	9~36	40	±12	±250	0	85	330
MU6D-2415D	24	9~36	40	±15	±200	0	88	220
MU6D-2424D	24	9~36	40	±24	±125	0	86	100
MU6D-4803	48	18~75	80	3.3	1500	0	80	1800
MU6D-4805	48	18~75	80	5	1200	0	84	1000
MU6D-4809	48	18~75	80	9	667	0	85	680
MU6D-4812	48	18~75	80	12	500	0	87	470

MU6D Series

6W, Wide 4:1 Input Range, 1.5KV Isolation, DIP24 Package DC/DC Converters

Model Numbers [continued]

Model Number	Input Voltage [VDC]			V _{OUT} [VDC]	Output Current [mA]		Efficiency [%] Typ.	Capacitive Load [uF] Max.
	Nom.	*Range	*Max.		Max.	Min.		
MU6D-4815	48	18~75	80	15	400	0	88	220
MU6D-4824	48	18~75	80	24	250	0	87	100
MU6D-4805D	48	18~75	80	±5	±600	0	83	680
MU6D-4812D	48	18~75	80	±12	±250	0	87	330
MU6D-4815D	48	18~75	80	±15	±200	0	88	220

* Only typical models are listed. Other models may be available upon request.

* Input voltage exceed the Max. value may cause permanent damage.

* Standard models in MU6D series are 1.5KV isolation single and dual outputs. See MUK6D series for 3KV isolation models

Electrical Specifications

Unless otherwise indicated, specifications are measured at T_A=25°C, nominal input voltage, full load after warm up.

Parameters	Conditions	Min.	Typ.	Max.	Unit	Note
Input current Full load	V _{IN, Nom} =24V	-	302	-	mA	
	V _{IN, Nom} =48V	-	156	-		
Input current No load	V _{IN, Nom} =24V	-	5	-	mA	
	V _{IN, Nom} =48V	-	4	-		
Reflected ripple current		-	20	-	mA	
Input voltage surge 1 second max	V _{IN, Nom} = 24V	-0.7	-	50	Vdc	
	V _{IN, Nom} = 48V	-0.7	-	100		
Startup input voltage	V _{IN, Nom} = 24V	-	-	9	Vdc	
	V _{IN, Nom} = 48V	-	-	18		
Input under voltage shutdown	V _{IN, Nom} = 24V	5.5	6.5	-	Vdc	
	V _{IN, Nom} = 48V	14.0	15.5	-		
Output voltage accuracy		-	±1	±3	%	
Output voltage balance Dual output with balanced load		-	±0.5	±1.5	%	
Line regulation Full load, V _{IN} = V _{IN, Min} to V _{IN, Max}	Main output	-	±0.2	±0.5	%	
	Other output	-	±0.5	±1.0		
Load regulation I _{OUT} =5% to 100% of I _{OUT, rated}	Main output	-	±0.5	±1.0	%	
	Other output	-	±0.5	±1.5		
Temperature coefficient	Full load	-	-	0.03	%/°C	
Output ripple and noise 20MHz bandwidth, peak to peak		-	60	85	mV	
Cross regulation Dual output, I _{OUT, main} =50% of I _{OUT, rated} , I _{OUT, other} =10% to 100% of I _{OUT, rated}		-	-	±5	%	

Electrical Specifications [continued]

Parameters	Conditions	Min.	Typ.	Max.	Unit	Note
Dynamic load response <small>I_{OUT}=25%~50%~75% of I_{OUT,rated}</small>	Peak deviation**		±5	±8	% V _{OUT}	**V _{OUT} =3.3V, 5V, ±5V
	Peak deviation	-	±3	±5	% V _{OUT}	
	Recovery time		300	500	µS	
Output over voltage protection		110	-	160	% V _{OUT}	
Output over current protection		110	140	190	% I _{OUT}	
Output short circuit protection		Continuous, automatic recovery, hiccup				

* Operating with less than 5% of rated load will not cause damage to the converters, but the performances data may not fall into the specifications, and stable operating is not assured.

General Specifications

Parameters	Conditions	Min.	Typ.	Max.	Unit	Note
Isolation voltage <small>1 minute, leakage current 1mA max.</small>	I/P to O/P	1500	-	-	VDC	
Isolation resistance <small>Tested at 500VDC</small>	I/P to O/P	1000	-	-	M ohm	
Isolation capacitance <small>100KHz, 0.1V</small>	I/P to O/P	-	1000	-	pF	
Switching frequency*	Full load	-	300	-	KHz	PWM mode
Operating temperature	See "Derating Curve"	-40	-	+85	°C	
Storage temperature		-55	-	+125	°C	
Storage humidity	None condensing	5	-	95	%RH	
Pin soldering temperature		-	-	300	°C	
Vibration		IEC/EN61373 - Category 1, Grade B				
Cooling method		Free air convection				
Case material		Aluminum alloy				
MTBF	MIL-HDBK-217F	>1,000,000 Hours, T _A =25°C				
Design based on standards		UL/EN/IEC 62368-1				
Safety certifications		EN/IEC 62368-1				
EMC		CISPR32, EN55032 Class B with external circuit IEC/EN61000-4-2, 3, 4, 5, 6				
Size, and Weight		32 x 20 x 11.1 mm, 14g				

* Switching frequency is measured at full load. The converter reduces the switching frequency at low load (less than 50% load) for better efficiency.

Characteristic Curves

Derating Curve

Output vs Ambient Temperature

No heatsink

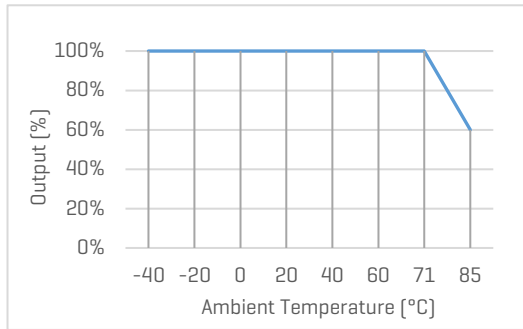

Efficiency Curve

Efficiency vs Input Voltage

MU6D-2405, with full Load

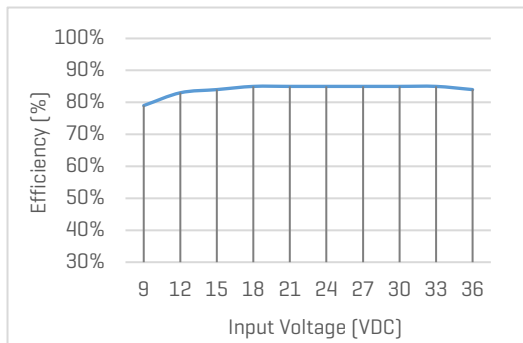

Efficiency vs Load

MU6D-2405, with nominal input voltage

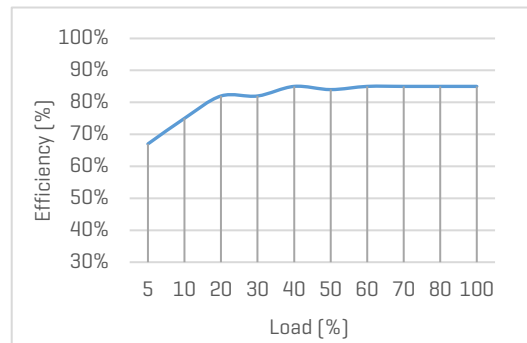

MU6D-4815D, with full Load

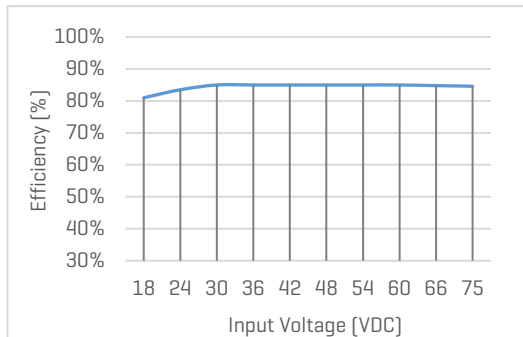

MU6D-4815D, with nominal input voltage

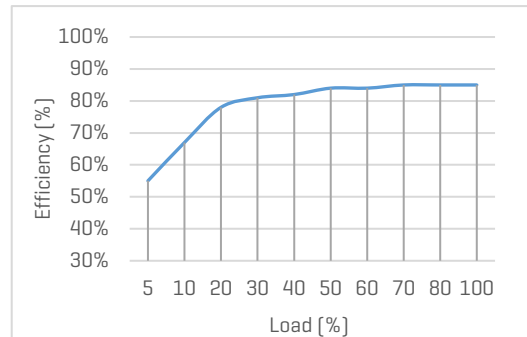

Recommended Application Circuit

Typical Application Circuit

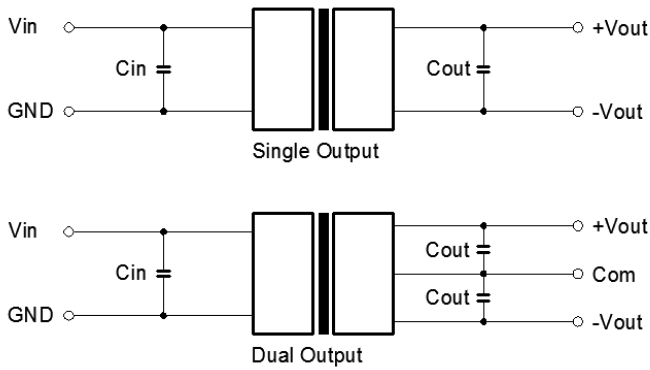

Figure 1. Typical external circuit

Note

*Typical application circuit is to further lower the input and output ripple. It is not required for general use.

*Recommended component specifications are typical values. Excessive external capacitive load may cause startup problem.

[Table 1] Recommended component spec

Input voltage	24V	48V
C_{IN}	100uF, 50V	10...47uF, 100V
C_{OUT}	10uF, 50V	

Circuit for EMC Enhancement

*Use this application circuit to meet Class B EMC performance.

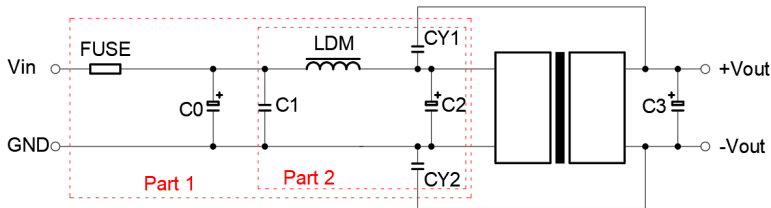

Figure 2. Circuit for EMC enhancement

[Table 2] Recommended component spec

Component	LDM	C0, C2	C1	CY1, CY2
$V_{IN}=24V$	4.7uH	330uF, 50V	1uF, 50V	1nF, 2KV
$V_{IN}=48V$	4.7uH	330uF, 100V	1uF, 100V	1nF, 2KV

* "Fuse" to be selected according to application needs. "C3" refer to relative C_{OUT} values in Table 1.

Mechanical Specifications

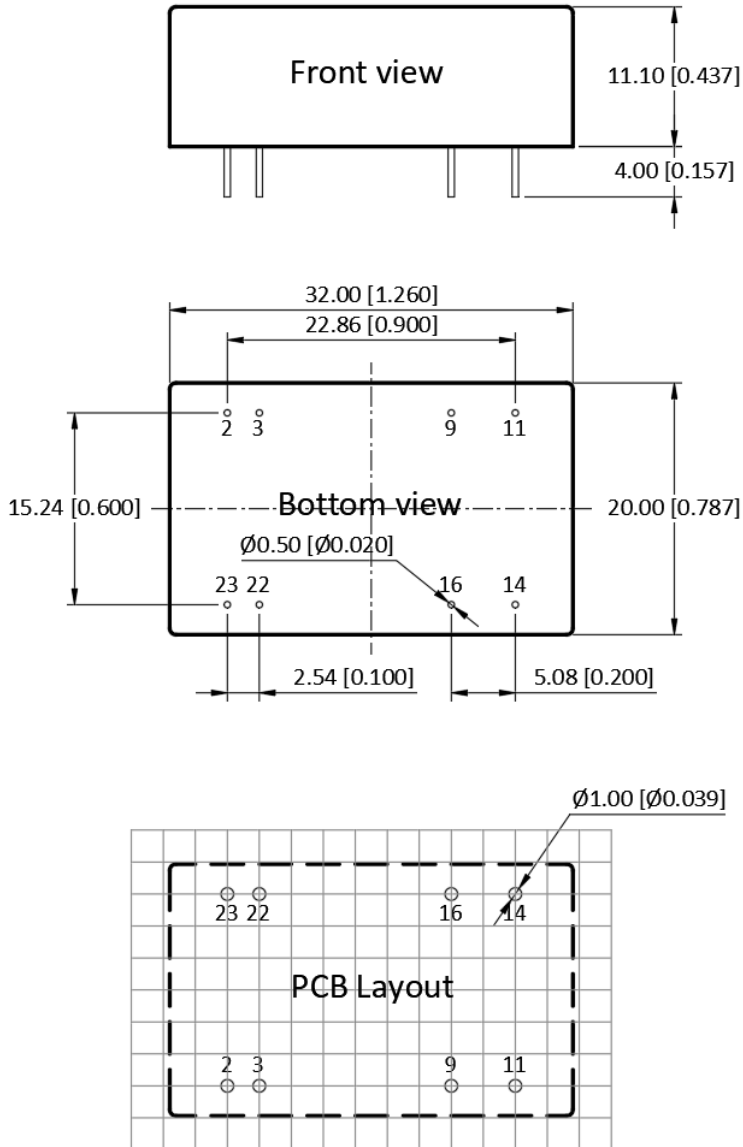

Pin Definition

Pin #	Single Out	Dual Out
2, 3	GND	GND
9	No pin	COM
11	No connection	-V _{OUT}
14	+V _{OUT}	+V _{OUT}
16	0V	COM
22, 23	V _{IN}	V _{IN}

* Unless otherwise specified unit: mm [inch]

* General tolerance: ±0.50 [±0.020]

* Pin thickness: ±0.10 [±0.004]

* Footprint grid 2.54 x 2.54 mm