

# MEK1S Series

1W, Unregulated, 3KV Isolation, DC/DC Converters

## Features

- ▶ Rated power: 1W max
- ▶ Input voltage range  $\pm 10\%$
- ▶ Unregulated output
- ▶ High efficiency up to 89%
- ▶ Isolation voltage 3KVDC
- ▶ Small no load input current
- ▶ Operating temp. range: -40 ~ +105°C ambient
- ▶ RoHS compliant
- ▶ Compact SIP7 package
- ▶ Continuous short circuit protection
- ▶ Meet UL/EN/IEC 62368-1 EN 55032 Class B
- ▶ 5 year warranty



## Overview

The MEK1S series are unregulated SIP7 package DC/DC converters with single or dual outputs, and 3KVDC isolation. These converters feature high efficiency, low ripple and noise, continuous short circuit protection, and wide operating temperature range. They are widely used in distributed power system in industrial applications where isolation and voltage converting is needed.

## Model Numbers

Model Number	Input Voltage [VDC] $\pm 10\%$	Output Voltage [VDC]	Output Current [mA] Max.	Efficiency [%] Typ.	Capacitive Load [ $\mu$ F] Max.
MEK1S-0303	3.3	3.3	303	82	4000
MEK1S-0305	3.3	5	200	83	4000
MEK1S-0309	3.3	9	111	84	2000
MEK1S-0312	3.3	12	84	85	1000
MEK1S-0315	3.3	15	67	85	680
MEK1S-0324	3.3	24	42	84	560
MEK1S-0503	5	3.3	303	83	4000
MEK1S-0505 <sup>[1]</sup>	5	5	200	86	4000
MEK1S-0509	5	9	111	86	2000
MEK1S-0512 <sup>[1]</sup>	5	12	84	88	1000
MEK1S-0515	5	15	67	88	680
MEK1S-0524	5	24	42	89	560
MEK1S-0503D	5	$\pm 3.3$	$\pm 152$	76	$\pm 2000$
MEK1S-0505D	5	$\pm 5$	$\pm 100$	86	$\pm 2000$
MEK1S-0509D	5	$\pm 9$	$\pm 56$	86	$\pm 1000$
MEK1S-0512D	5	$\pm 12$	$\pm 42$	88	$\pm 560$
MEK1S-0515D	5	$\pm 15$	$\pm 34$	88	$\pm 220$
MEK1S-0524D	5	$\pm 24$	$\pm 21$	88	$\pm 100$

# MEK1S Series

1W, Unregulated, 3KV Isolation, DC/DC Converters

## Model Numbers

Model Number	Input Voltage [VDC]	Output Voltage [VDC]	Output Current [mA] Max.	Efficiency [%] Typ.	Capacitive Load [uF] Max.
MEK1S-1203	12	3.3	303	84	4000
MEK1S-1205	12	5	200	86	4000
MEK1S-1209	12	9	111	87	2000
MEK1S-1212	12	12	84	87	1000
MEK1S-1215	12	15	67	88	680
MEK1S-1224	12	24	42	89	560
MEK1S-1203D	12	±3.3	±152	84	±2000
MEK1S-1205D	12	±5	±100	86	±2000
MEK1S-1209D	12	±9	±56	87	±1000
MEK1S-1212D	12	±12	±42	87	±560
MEK1S-1215D	12	±15	±34	88	±220
MEK1S-1224D	12	±24	±21	84	±100
MEK1S-1505	15	5	200	86	4000
MEK1S-1509	15	9	111	87	2000
MEK1S-1512	15	12	84	87	1000
MEK1S-1515	15	15	67	88	680
MEK1S-1524	15	24	42	84	560
MEK1S-1505D	15	±5	±100	86	±2000
MEK1S-1512D	15	±12	±42	87	±560
MEK1S-1515D	15	±15	±34	88	±220
MEK1S-1524D	15	±24	±21	84	±100
MEK1S-2403	24	3.3	303	84	4000
MEK1S-2405	24	5	200	87	4000
MEK1S-2409	24	9	111	88	2000
MEK1S-2412	24	12	84	88	1000
MEK1S-2415	24	15	67	88	680
MEK1S-2424	24	24	42	89	560
MEK1S-2405D	24	±5	±100	87	±2000
MEK1S-2409D	24	±9	±56	88	±1000
MEK1S-2412D	24	±12	±42	88	±560
MEK1S-2415D	24	±15	±34	88	±220
MEK1S-2424D	24	±24	±21	84	±100

Note <sup>[1]</sup>: Models that are certified to UL62368-1.

### Electrical Specifications

Unless otherwise indicated, specifications are measured at  $T_A=25^{\circ}\text{C}$ , nominal input voltage, full load after warm up.

Parameters	Conditions	Min.	Typ.	Max.	Unit
Input current Full load	$V_{IN}=3.3\text{V}$	-	370	390	mA
	$V_{IN}=5\text{V}$		230	260	
	$V_{IN}=12\text{V}$		99	105	
	$V_{IN}=15\text{V}$		78	85	
	$V_{IN}=24\text{V}$		50	55	
Input current No load		-	3	15	mA
Reflected Ripple Current		-	15	-	mA
Surge voltage 1 second max	$V_{IN}=3.3\text{V}$	-0.7	-	5	VDC
	$V_{IN}=5\text{V}$	-0.7		9	
	$V_{IN}=12\text{V}$	-0.7		18	
	$V_{IN}=15\text{V}$	-0.7		21	
	$V_{IN}=24\text{V}$	-0.7		30	
Output voltage accuracy	All models	Refer to graphic in "Characteristic Curves" section			
Line regulation For $V_{IN}$ change of $\pm 1\%$	$V_{OUT}=3.3\text{V}$	-	-	$\pm 1.5$	%
	All others			$\pm 1.2$	
Load regulation [2] $I_{OUT}=10\%$ to $100\%$ of $I_{OUT, rated}$	$V_{OUT}=3.3\text{V}$	-	10	20	%
	Others		8	15	
Temperature coefficient	Full load	-	$\pm 0.03$	-	$\%/^{\circ}\text{C}$
Output ripple and noise	20MHz bandwidth	-	45	100	mVp-p
Output short circuit protection		Continuous, automatic recovery			
Input filter		Capacitor			
Hot plug		None			

Note [2]: Operating with less than 10% of rated load will not cause permanent damage to the converters, but the performances data may not fall into the specifications, and reliable operating is not assured. Dual output models need to operate with balanced load. The load difference between two outputs over 10% may cause unstable operating of the converter.

## General Specifications

Parameters	Conditions	Min.	Typ.	Max.	Unit
<b>Isolation voltage</b> 1 minute, leakage current <1mA	Input to Output	3000	-	-	VDC
<b>Isolation resistance</b> Tested at 500VDC	Input to Output	1000	-	-	M ohm
<b>Isolation capacitance</b> 100KHz, 0.1V	Input to Output	-	20	-	pF
<b>Switching frequency</b>	Full load	-	220	-	KHz
<b>Temperature rise at case</b>	Full load	-	15	-	°C
<b>Operating temperature</b>	See "Derating Curve"	-40	-	+105	°C
<b>Storage temperature</b>		-55	-	+125	°C
<b>Storage humidity</b>	Non-condensing	5	-	95	%RH
<b>Pin soldering resistance</b> 1.5mm away from case for 10 sec		-	-	300	°C
<b>Case material</b>		Black plastic UL94-V0			
<b>Cooling method</b>		Free air convection			
<b>Vibration</b>		10-150Hz, 5G, 0.75mm along X, Y and Z			
<b>MTBF</b>	MIL-HDBK-217F	>3,500,000 Hours, T <sub>A</sub> =25°C			
<b>Safety standards</b>		UL/EN/IEC 62368-1			
<b>EMC standards</b>	CISPR32, EN55032	Class B with "External Circuit"			
ESD	IEC/EN61000-4-2	Contact ±4kV, Air ±8kV, perf. Criteria B			
<b>Size &amp; Weight</b>		19.65x6x10.16mm, 2.1g Typ.			

# MEK1S Series

1W, Unregulated, 3KV Isolation, DC/DC Converters

## Characteristic Curves

### Output vs Ambient Temperature

All models

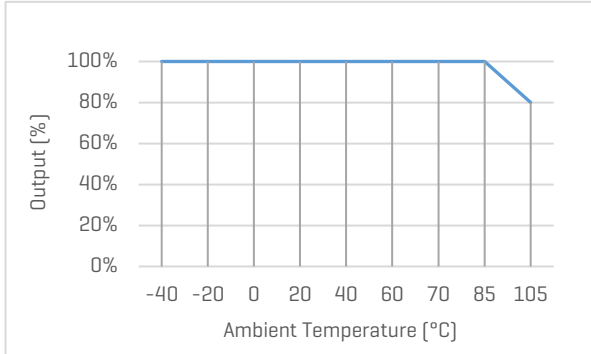

### Output Voltage Accuracy vs Load

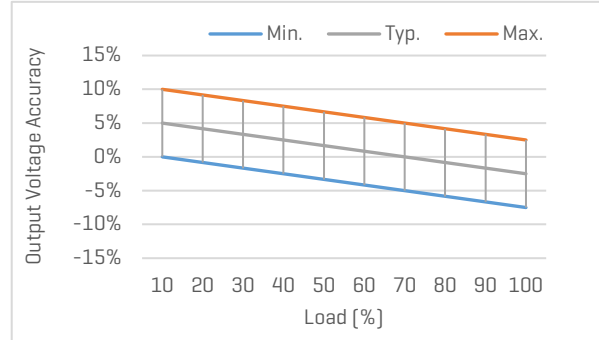

### Efficiency vs Input Voltage

MEK1S-0505, with full Load

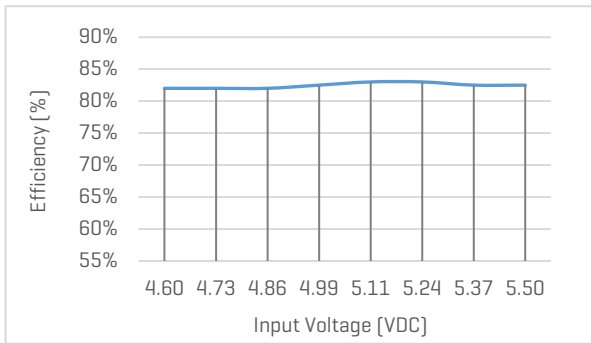

### Efficiency vs Load

MEK1S-0505, with nominal input voltage

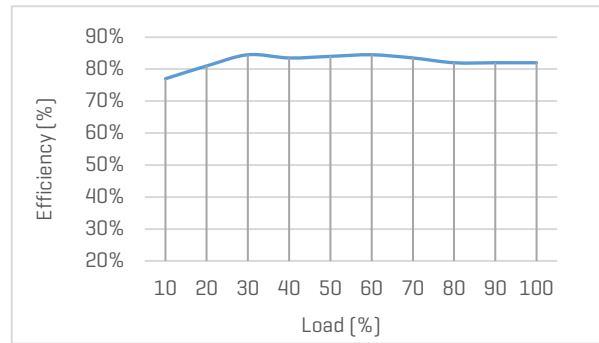

### Efficiency vs Input Voltage

MEK1S-1205, with full Load

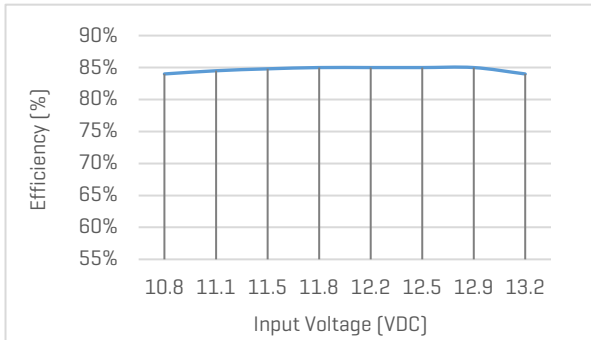

### Efficiency vs Load

MEK1S-1205, with nominal input voltage

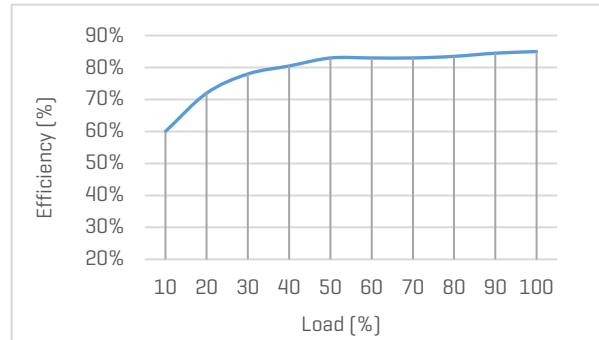

# MEK1S Series

1W, Unregulated, 3KV Isolation, DC/DC Converters

## Recommended External Circuit

### Typical Application Circuit

\*Typical application circuit is to further lower the input and output ripple. It is not mandatory.

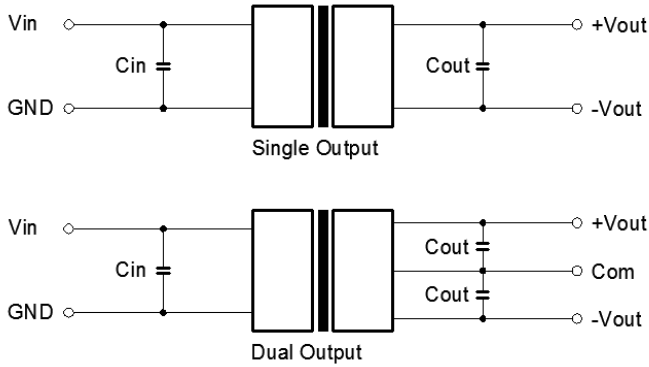

Figure 1. Typical external circuit

[Table 1] Recommended component spec

Input voltage	3.3, 5V	12V	15V	24V
$C_{IN}$	4.7uF, 16V	2.2uF, 25V	2.2uF, 25V	1uF, 50V

[Table 2] Recommended component spec

Output voltage	3.3, 5V	9V	12V	15V	24V
$C_{OUT}$	10uF, 16V	4.7uF, 16V	2.2uF, 25V	1uF, 25V	0.47uF, 50V

### EMC Enhancement for EN55032 Class B

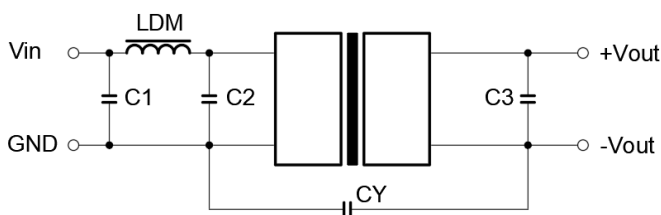

Figure 2. Circuit for EMC enhancement

[Table 3] Recommended component spec

Component	LDM	C1, C2	CY
$C_{OUT}$	6.8uH	4.7uF, 50V	1nF, 4KV

\*"C3" refer to  $C_{OUT}$  in [Table 2]

## Mechanical Specifications

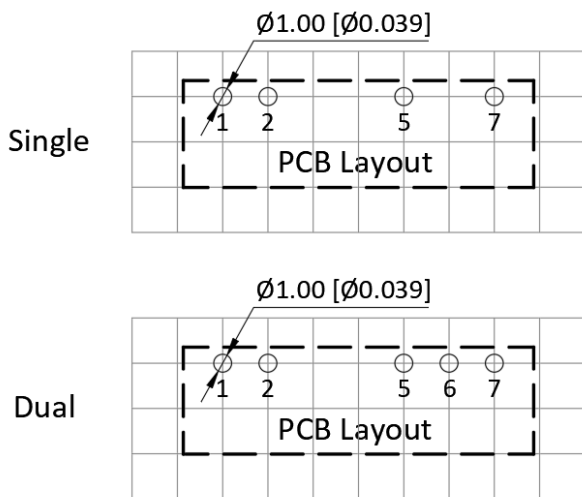
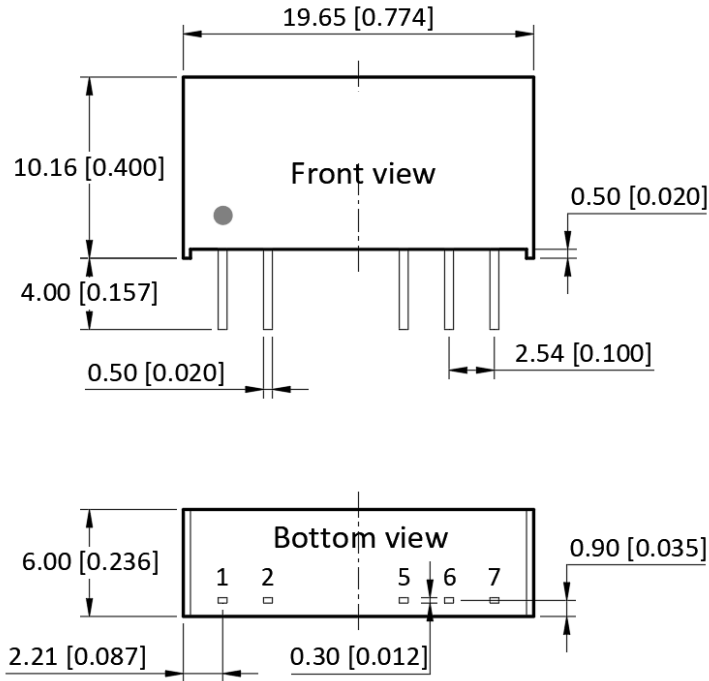

### Pin Definition

Pin #	Single Out	Dual Out
1	+V <sub>IN</sub>	+V <sub>IN</sub>
2	-V <sub>IN</sub>	-V <sub>IN</sub>
5	-V <sub>OUT</sub>	-V <sub>OUT</sub>
6	No Pin	COM
7	+V <sub>OUT</sub>	+V <sub>OUT</sub>

\* Unless otherwise specified unit: mm [inch]

\* General tolerance:  $\pm 0.50$  [ $\pm 0.020$ ]

\* Pin thickness:  $\pm 0.10$  [ $\pm 0.004$ ]

\* Footprint grid 2.54 x 2.54 mm